

KESO 4000

The patented security system KESO 4000S Omega



A brand on the road to success

Sustainable synergies: KESO and ASSA ABLOY

Security is a powerful word. It not only encompasses an endless range of technologies but also emotional aspects that we deal with every single day. Quality, a professional partnership and perfect solutions are always required.

The KESO brand and the Swedish ASSA ABLOY group stand by their promise and aim to constantly fulfil and exceed the high requirements established by their customers and partners.

Contents

■ KESO and ASSA ABLOY	2
■ The system KESO 4000	3
■ Solutions and references	4
■ Product expertise	6
■ Omega technology	7
■ Keys	8
■ Mechanical cylinders	9
■ Mechatronics	12
■ Mechatronic cylinders	14
■ k-entry® management software	16
■ Designing masterkey systems	17
■ Planning masterkey systems	18
■ Contact	20



Swiss quality for the long term

Thanks to ongoing developments, a holistic product philosophy and the expert knowledge of our development department, we can continue to guarantee the compatibility and modularity of all systems in the future.

International partnerships and ASSA ABLOY guarantee technological transfer in all areas. KESO relies on legendary Swiss quality and ensures long-term sustainability.

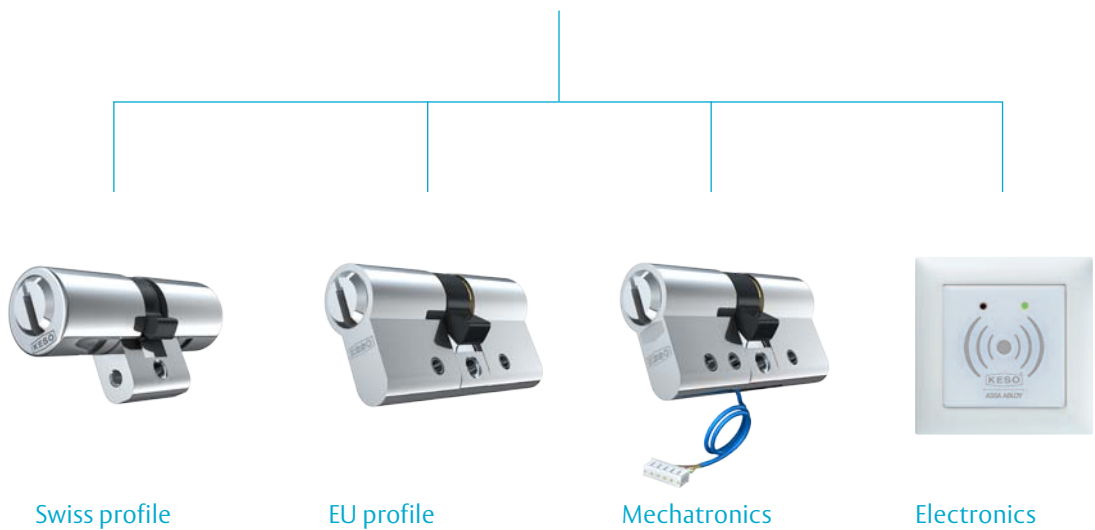

KESO 4000 for diverse planning processes

- Increased line shift for enhanced permutation capabilities
- Excellent line shiftment for greater combinatorics
- Wide range of permutations thanks to more drilling picture variations
- Profiled shoulder
- Modular technology in the EU profile

- Complete range incl. mechatronics
- Closed key channel
- Drilling, tear-off and pull protection
- Colour cap keys also available in the long and extra-long versions in 19 models
- KESO 4000S Omega with interactive locking pin
- Patent valid until 2023

The KESO principle ensures sustainability

Small components,
great efficiency

Today, KESO is the brand that combines high-quality mechanical locking systems with state-of-the-art, high-tech electronics. These benefits are evident not only in relation to private home doors but also right through to complex systems in large companies.

The precise determination of requirements and the careful alignment of all systems are key to the secure use on an everyday basis. This is where the expertise of KESO specialists comes into its own.

Solutions for private homes, banks and industry through to football stadiums



A good reference is the best sales argument

High levels of footfall demand the highest security. KESO therefore offers specially developed solutions for all sector-specific requirements. We guarantee years of operational readiness at low cost and simple, practical operation. A small excerpt from the current KESO reference list:

- Victorinox AG, Ibach-Schwyz
- Swiss Federal Railways, Bern
- Cantonal police, Schwyz
- Transco (Energy), Abu Dhabi, U.A.E.
- HSH Nordbank Arena, Hamburg
- University Hospital, Basel
- Schiphol Airport, Amsterdam



The Swiss Federal Railways put their trust in KESO 4000S with Omega technology

Tradition-based expertise with patent protection until 2023

The KESO 4000 stands out clearly from existing systems and offers an almost endless number of locking options. More drill patterns and greater line displacement make far greater combinatorics possible. Together with the profiled shoulder,

KESO 4000 is a premium-quality precision masterpiece. The mechatronic range is also available in this system and is also patented.

1. Shifting of the drilling lines for greater permutations

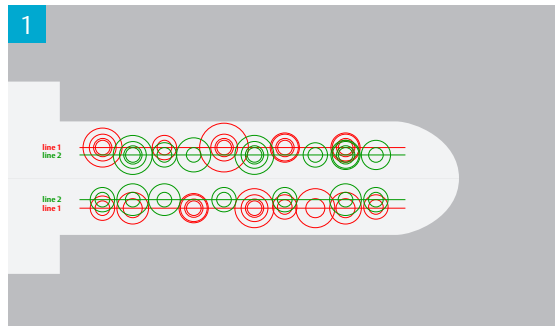

2. Patented front profile



3. Hardened steel bolts as standard

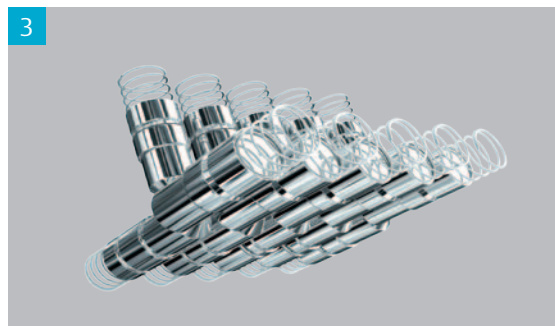

4. Cylinder pins in several designs

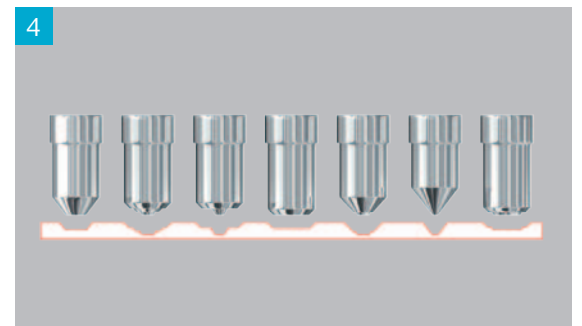

5. Available with standard Sidra (diecast) or Stainless Steel (CrNi) housings



6. Module cylinders in EU profile



VdS class A & BZ+,
Drilling protection,
Tear-off protection,
Pulling protection



KESO 4000S Omega, interactive protection against copying

Protection against copying in the key and the cylinder

The technology integrated into the KESO Omega key has to be activated by the integrated, corresponding mechanism in the cylinder lock during

the opening function. This mechanism with interactive pins in the top edges of the key considerably increases copy protection for the key.

The soft 'click' of the Omega bolts when inserting the key demonstrates the precision and security of the technology.

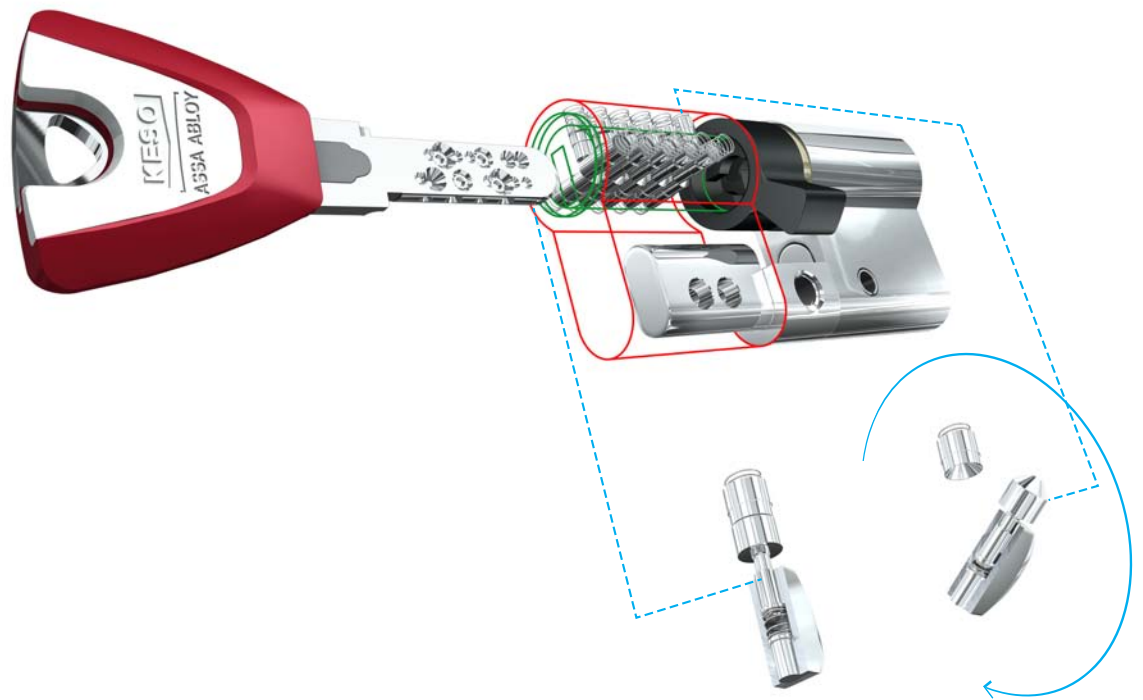

The key to your world

1. **Mechatronic key**
with Ω: 40.812.010

2. **Colour cap key**
with Ω: 40.970.010

3. **Long key**
with Ω: 40.810.010

Extra-long key
with Ω: 40.811.010

4. **Trapeze key**
with Ω: 40.100.010











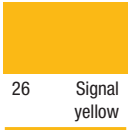

Round key
with Ω: 40.102.010

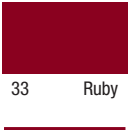

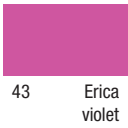
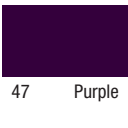
The colour caps ensure that keys can be identified quickly and easily. The precise design is far superior to conventional pull-on caps and has a pleasant feel.

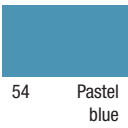
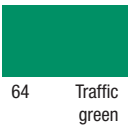
KESO colour caps are available for mechatronic keys, trapeze keys, extra-long keys and long keys. The mechatronic keys can be fitted with MIFAR or LEGIC chips.

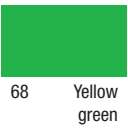
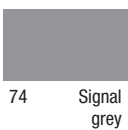
Ordering example for a 4000S Ω colour cap key Ruby:
Article number: 40.970.010.33

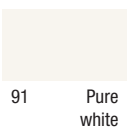
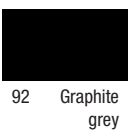
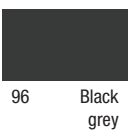
 26 Signal yellow	 27 Light ivory	 28 Neon orange	 29 Traffic orange	 30 Sulphur yellow	 33 Ruby	 34 Traffic red
 43 Erica violet	 47 Purple	 52 Ultramarine blue	 54 Pastel blue	 64 Traffic green	 65 Moss green	 68 Yellow green
 74 Signal grey	 86 Deer brown	 91 Pure white	 92 Graphite grey	 96 Black grey	Black grey only for the mechatronics keys 40.810 - 812	

Double cylinder CH

Basic length:
41.015/32.5/32.5
Additional lengths:
in 5 mm increments



Double cylinder EU

Basic length:
CrNi 41.215/30.0/30.0
Sidra 41.415/30.0/30.0
Extendible in 5 mm
increments

Thumbturn cylinder CH

Basic length:
41.019/32.5/32.5
Additional lengths:
in 5 mm increments



Thumbturn cylinder EU

Basic length:
CrNi 41.219/30.0/30.0
Sidra 41.419/30.0/30.0
Extendible in 5 mm
increments

Half cylinder CH

Basic length:
41.012/32.5
Additional lengths:
in 5 mm increments



Half cylinder EU

Basic length:
CrNi 41.214/30.0
Sidra 41.414/30.0
(total length 40 mm)
Extendible in 5 mm
increments

Short cylinder EU

Basic length:
41.43Y/14.0/14.0
Additional lengths:
41.43Y/16.0/16.0
41.43Y/18.0/18.0
41.43Y/26.0/26.0
Can be integrated
into masterkey systems

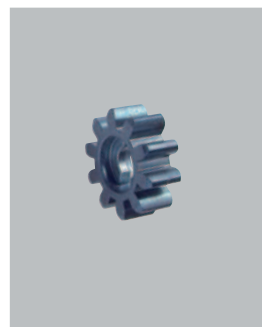

Multilock option gearwheel

at 41.015 art. E223MT
at 41.019 art. E225MT
at 41.215/41.415
art. E222MT
at 41.219/41.419
art. E224MT
Optionally available
with gearwheel cam, f.e.
Multilock

Mechanical cylinders and locks

Cylinder olive Ø 47 mm

44.007.1.035.R with
4-edge-pin 7x7 mm,
brushed, nickel-plated
housing.
Reducing bearing for
combined locks Ferma,
Terza and Steloc:
additional art. no. G044



Cylinder olive Ø 35 mm

44.014.1.035.R with
4-edge-pin 7x7 mm,
brushed, nickel-plated
housing.
Reducing bearing for
combined locks Ferma,
Terza and Steloc:
additional art. no. G044



Rim cylinder, centric

42.007
incl. escutcheon,
mounting plate and
mounting screws



Rim cylinder, eccentric

42.010, nickel-plated
brass incl. escutcheon,
mounting plate and
mounting screws



Window handle, angular

44.009 (160 mm)
Angular version with
4-edge-pin 7x7 mm,
brushed, nickel-plated
housing



Window handle

44.119 (155 mm)
Rounded version with
4-edge-pin 7x7 mm,
matte, nickel-plated
housing



T-handle cylinder

44.001.1.035.R with
4-edge-pin 7x7 mm,
brushed, nickel-plated
housing.
Reducing bearing for
combined locks Ferma,
Terza and Stelco:
additional art. no. G044



Switch cylinder

Ø 32 mm
46.019.00.1E
Nickel-plated brass.
Rotation movement
handled by switch
element



Switch cylinder 22

Ø 22 mm
46.052.304
Withdrawable position
for key 4x90°
Matte, nickel-plated
brass. Rotation
movement handled
by switch element.



Switch cylinder, multiple withdrawal

Ø 32 mm
46.052.104
Withdrawable position
for key 4x90°
Matte, nickel-plated brass.
Rotation movement
handled by switch
element.



Padlock

42.037.xxx
 .R25 = 25 mm stainless
 .025 = 25 mm hardened
 .R50 = 50 mm stainless
 .050 = 50 mm hardened
 .R70 = 70 mm stainless
 .R10 = 100 mm stainless
 .220 = with wire
 (length: 45 cm)

**Universal cylinder**

43.031.025.20 with
 universal bolt,
 locking cylinder for
 letter boxes and
 changing room lockers.
 Bolt available in
 different offsets and
 lengths.

**Dead lock**

43.074.025 R
 Furniture lock left,
 right for drawer or
 covers. Accessories:
 corner strike plate
 Art. no. G252,
 Escutcheon art. no.
 G006

**Dead lock**

43.084.025, D = 30 R
 Furniture lock left, right
 for drawer or covers in
 backset of 30 to 60 mm.
 Accessories:
 Escutcheon art. no.
 G006

**Dead lock with thumbturn**

42.064
 Bolt lock, double-
 rotation, feed 21 mm.
 Lock case silver-grey.
 Convertible left/right.
 Incl. outer cylinder
 42.045

**Dead lock**

43.030.025 C
 For screw-in or
 embedding.
 Left or right for doors
 and drawers.
 Backset 20 mm

**Universal mounting cylinder**

Basic length:
 43.008.025
 For furniture,
 switches, etc.
 Can be combined
 with a large number
 of actuators and cams.

**Push cylinder**

12mm stroke
 43.040.027.12
 Keyless locking
 43.040.Z27.12
 Key not removable
 in unlocked position
 43.040.A27.12
 Unlocking and locking
 with key



Mechatronics for greater convenience and control

KESO i-handle HS



Modern electronic components add a new dimension to tailor-made security. Existing systems can be retrofitted at any time while logical designs for integration purposes also take into account the cost factor. The popular mechanical precision cuttings

in the mechatronic versions are supplemented by electronic functions such as immediate locking in the event of a lost key or the programming of temporally-restricted access rights.

The key opens mechanical, mechatronic and contact-free systems.

Two RFID technologies can be integrated into the key, which can therefore also control third-party products such as alarm systems, coffee machines and time recordings.

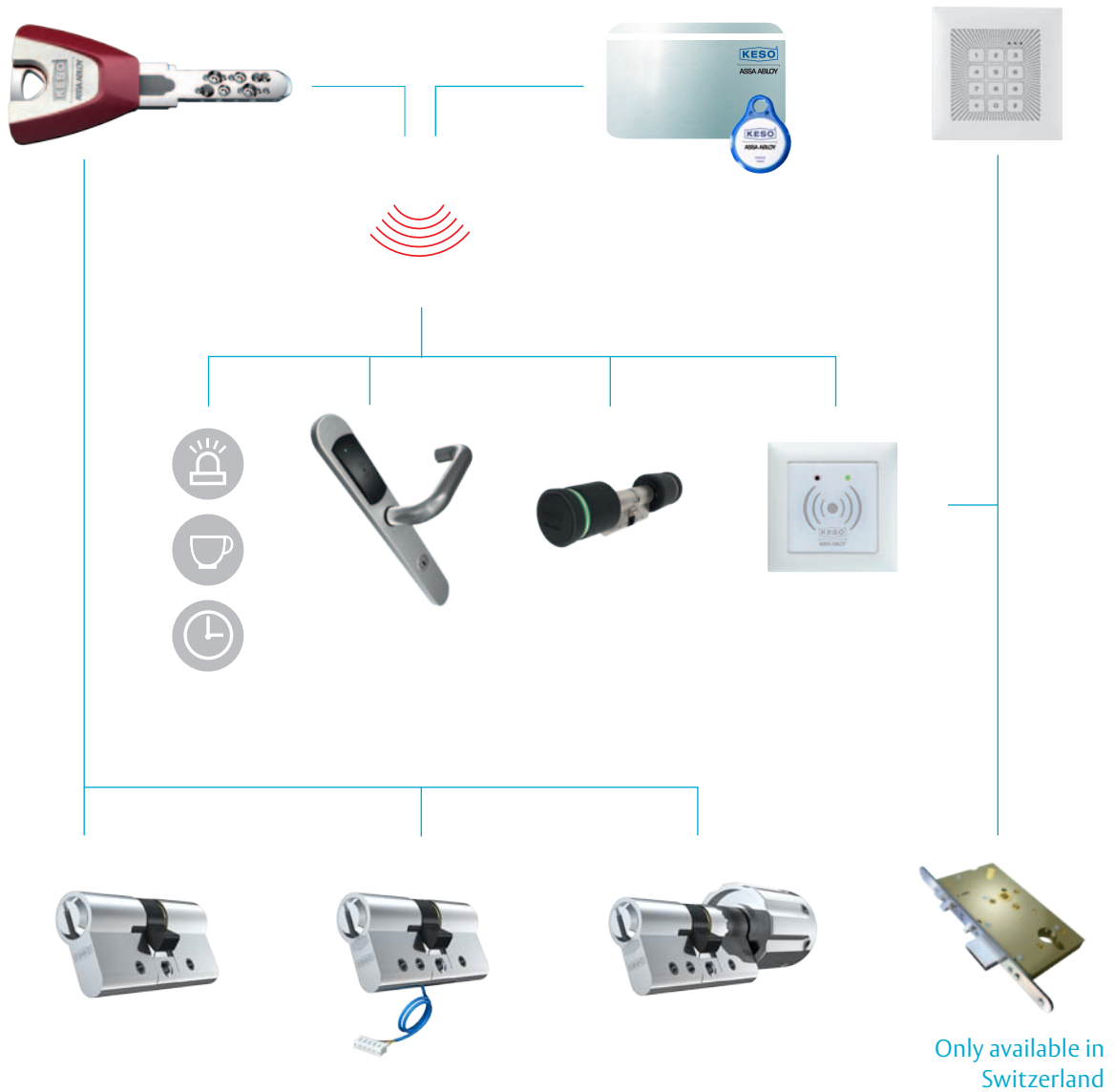

Main mechatronics range

KESO k-entry®

Standard software
K.719
Upgrade Net 16
K.720
Upgrade NOK
K.724
For managing and
programming locking
systems.



Programmer PPG V2

K.536
For programming
identification media and
mechatronic products.

Mechatronic key

with Ω : 40.812.010
(option: additional RFID
LEGIC or Mifare for
customized application)



Keycard

10.953
(option:
additional RFID)

Key tags

10.993
(option:
additional RFID)

Mechatronic double cylinder EuroSwiss

Basic length:
41.53F/30.0/30.0
Additional lengths:
at 5 mm increments
(requires electronics
EG.707)



Mechatronic double cylinder EU

Basic length:
41.43F/30.0/30.0
Additional lengths:
at 5 mm increments
(requires electronics
EG.707)

Mechatronic thumbturn cylinder EuroSwiss

Basic length (60 mm
without knob)
41.53G/30.0/30.0
Additional lengths:
at 5 mm increments
(requires electronics
EG.707)



Mechatronic thumbturn cylinder EU

Basic length (60 mm
without knob)
41.43G/30.0/30.0
Additional lengths:
at 5 mm increments
(requires electronics
EG.707)

BS electronic fitting

Dummy: EG.707.
PTB.03.01.02.00.02
17 mm: EG.707.
PTB.03.01.02.04.02
22 mm: EG.707.
PTB.03.01.02.01.02
8000 memory per
electronic system



BS electronic faceplate

Short:
EG.707.PTB.01.10.02
Long:
EG.707.PTB.02.10.02
8000 memory per
electronic system

Mechatronic Knob EuroSwiss

Integrated electronics
Basic length (60 mm without knob)
41.53H/30.0/30.0KT
Additional lengths:
at 5 mm increments
8000 memory per electronic system



Mechatronic Knob EU

Integrated electronics
Basic length (60 mm without knob)
41.43H/30.0/30.0KT
Additional lengths:
at 5 mm increments
8000 memory per electronic system



KESO i-pin

Inner area UP edizio due
K.557/UP
Outer area UP K.558/UP
Controls unlocking systems and manages
8000 codes
Prerequisite:
KESO Access Point

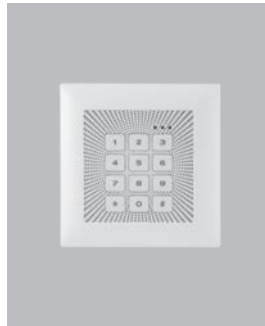

KESO i-turn

Double door knob with integrated electronic system. Basic length (60 mm without knob)
21.43V/30.0/30.0.KT
Additional lengths:
at 5 mm increments
8000 memory per electronic system



KESO i-reader

Internal use:
K.550 UP edizio due
External use:
K.549 UP (IP55)
Enables contact-free identification
Prerequisite:
KESO Access Point



KESO i-handle S

EG.711
Mechatronic escutcheon solution for contact-free unlocking.

KESO i-handle HS

EG.712
For tubular frame and exterior doors



Access Point

EG.716.000.00.SA
DIN rail electronics
8000 memory per electronic system



KESO Spray

G.992/56/10
For taking care of mechatronic and mechanical cylinder locks.
Protects against corrosion, lubricates and is non-sticky.



KESO k-entry®, the organisation, programming and networking software

KESO k-entry® manages, programmes and controls users, keys, cylinders and doors

The KESO management software k-entry® combines mechanical, mechatronic and electronic locking systems in an organisational network. It is the ideal system for building operators that keep many expansion and integration options open. KESO k-entry® enables you to manage mechanical systems, programme offline

mechatronic solutions or control networked systems online. "Network-on-key" can also be used to wirelessly control networks via a key. The key, keycard or key tag therefore becomes a data carrier and transfers the information from the software to offline or stand-alone systems.

k-entry® software

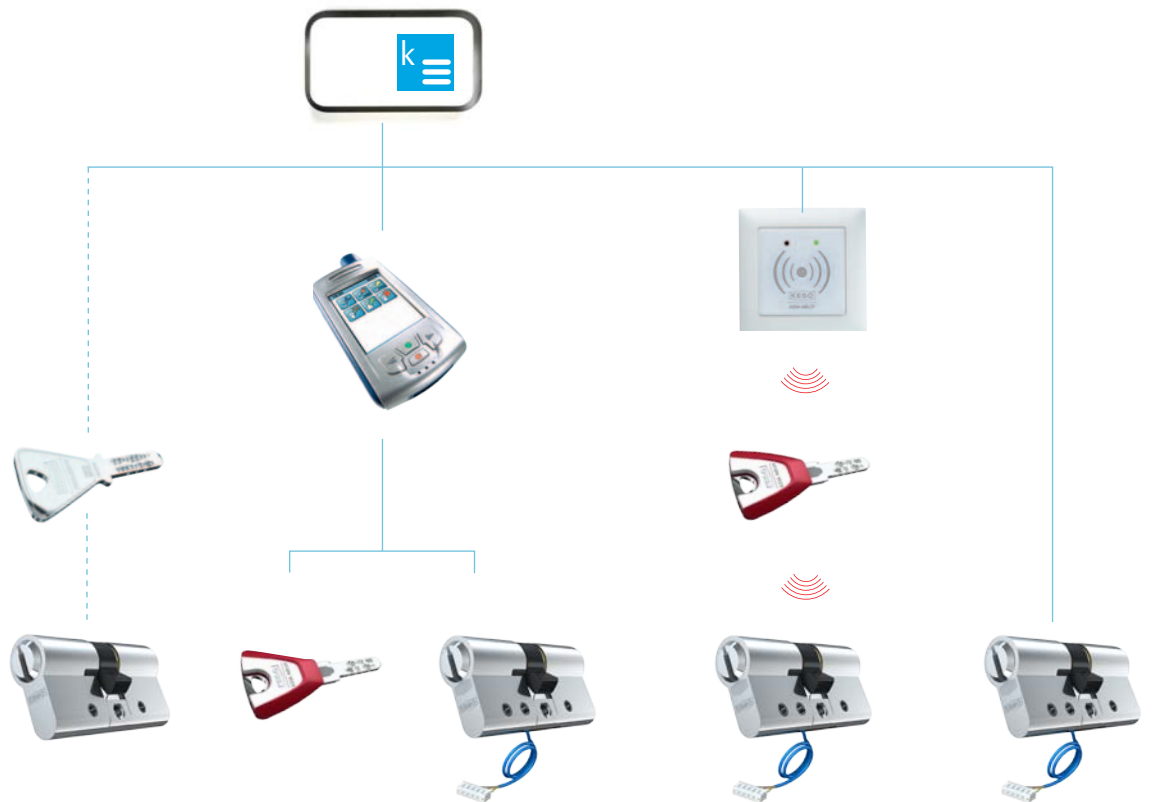

Mechanics
Manage mechanical systems.

Stand-alone
Manage and programme mechatronic and electronic locking system technology with the aid of a KESO PPG II device.

Network-on-Key
Manage and programme mechatronic and electronic locking system technology via data carrier (e.g. KESO mechatronic key).

Online
Manage, programme and control mechatronic and electronic locking system technology via Ethernet.

Project planning advice for masterkey systems

When implementing masterkey systems, a design-centred approach provides greater security. From the analysis to the specific use, all factors are carefully reviewed in cooperation with customers and planners. A clear overview and the adherence

to costs are guaranteed throughout the process. KESO specialists are available at all times and offer a broad range of expertise in planning, project planning and maintenance.

1. Analysis

- Security requirements
- Company structures
- Workflow diagram
- Site plans
- Matrix

2. Concept

- Strategy
- Concept planning
- Master plan
- Budget plan
- Schedule

3. Implementation

- Product platform
- Key lists
- Lock plan
- Door matrix
- Diagrams
- Product order

4. Use

- Installation
- Handover
- Training
- Maintenance agreements
- Inspections
- Support

Planning and ordering masterkey systems is fairly simple. The process is shown in the sample plan below. All the doors are listed horizontally; the vertical columns are for the keys.

More information about planning of masterkey systems can be obtained at KESO training courses or from your specialist.

Lock plans can be downloaded from www.assaabloy.ch

KESO		Kunden-Nr.: 123456	Seite: 1 / 1											
ASSA ABLOY		Fachpartner: Musterpartner												
		Objekt: Heim Muster, Spitalstr. 14 1234 Musterhausen												
		Anlage-Nr.:												
		System: 3000												
		KEK: JA												
		Schlüsselform: KEKcombi												
		Registriert: Ja												
Code:	F	Omega: Ja:	<input type="checkbox"/>	Bei Omega Zylinder/Schlüssel bitte Omega-seite/Schlüssel Bezeichnen										
				Schlüssel										
				Bezeichnung	Zusatzebezeichnung									
Anzahl	3	E-1000A	Pass											
	5	E-1100B1	Hauswart											
	10	E-220B2	Leitung Pflege											
	15	E-221/1C1	Pflege											
	3	2100/1	Lager Heim											
	3	2100/2	Lager Küche											
	3	E-3001Z00	E11 Zimmer 1											
	3	E-3002Z00	E12 Zimmer 2											
	3	E-3003Z00	I01 Zimmer 3											
	3	E-3004Z00	I02 Zimmer 4											
Form	92													
Farbe	34													
				52	10	E-220B2	Leitung Pflege							
				54	15	E-221/1C1	Pflege							
				28	3	2100/1	Lager Heim							
				29	3	2100/2	Lager Küche							
				33	3	E-3001Z00	E11 Zimmer 1							
				33	3	E-3002Z00	E12 Zimmer 2							
				33	3	E-3003Z00	I01 Zimmer 3							
				33	3	E-3004Z00	I02 Zimmer 4							
Zylinder														
Position	Tür- oder Raumbezeichnung	Zylinder Artikel-Nr.	Zylinderlänge in mm	Anzahl										
Untergeschoss														
Batch01	001 Leser Tiefgarage	E6.709.PTS	05/02/03/04/17	1										
Z00	001 Servicetüre Tiefgarage	31.583	30.0/30.0	1	X	X	X	X			X	X		
Z00-KEK	001 Servicetüre Tiefgarage	E6.707.PTB	01/10/02	1										
900/1	002 Hauswartraum	31.015	32.5/32.5	1	X	X								
900/2	003 Elektrorum	31.019	32.5/32.5	1	X	X								
900/3	004 Sanitär	31.066	27.5/37.5	1	X	X								
Z01	005 Kellerabschlüsse	31.019	42.5/37.5	2	X	X	X							
2100/1	006 Lager Heim	31.015	32.5/32.5	1	X	X	X		X					
2100/2	007 Lager Küche	31.015	32.5/32.5	1	X	X	X		X					
1	2	3	4	5	6							7		

- 1 Header data (system no. if expanding existing systems)
KEK: mechatronics yes/no
Key shape: colour cap, trapeze, round, long or extra-long
Registered: yes/no
Code: determined from the system complexity.
Omega: yes/no
- 2 The position is married to the lock 7. The cylinder is labelled with the position (max. 10 characters).
- 3 The door or room name acts as help text for the installation location (max. 25 characters).
- 4 Cylinder article no. comprising the system/model, article and length
41.015/32.5/32.5
 - A and B lengths per 32.5 m (from centre of locking cam)
 - Article (CH-round double cylinder)
 - System/model (KESO 4000S Omega assembly cylinder)
- 5 Cylinder length A/B (32.5/32.5) from centre of locking cam in mm.
With thumbturn cylinders, the lock side is side A
- 6 Number of required cylinders
- 7 The matrix: cylinders that have to be opened with a key must be labelled here with an X
- 8 Additional name acts as help text for the distribution of keys
- 9 Number of required keys and their names
- 10 Colour of colour cap keys – see page xx (for keys without a colour cap, leave blank)

ASSA ABLOY is the
global leader in door
opening solutions,
dedicated to satisfying
end-user needs for
security, safety and
convenience.

ASSA ABLOY

ASSA ABLOY (Switzerland) Ltd.
Untere Schwandenstrasse 22
CH-8805 Richterswil
Telephone +41 44 787 34 34
Telefax +41 44 787 35 35
info@assaabloy.ch
www.assaabloy.ch

 **Mixed Sources**
Product group from well-managed
forests, and other controlled sources
www.fsc.org Cert no. SQS-COC-100144
© 1996 Forest Stewardship Council

PR.01.108/en 1.2012